

STRIP LED DOT FREE MANUAL USER

O Type

SIDE EMITTING

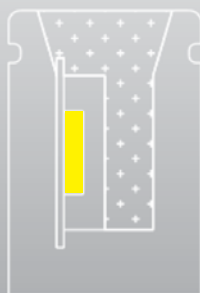

Product Features:

- Side-emitting, bendable laterally
- Extremely flat profile, perfect for recessed installation.
- IP65/67 Waterproof
- Dual color of silicone
- Hollow air layer for good heat dissipation

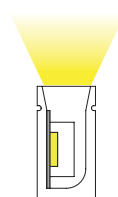

Side-emitting

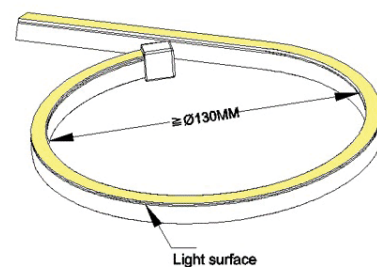

Applications:



Side-emitting, bendable laterally

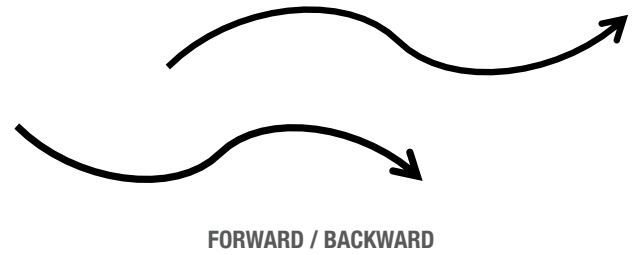
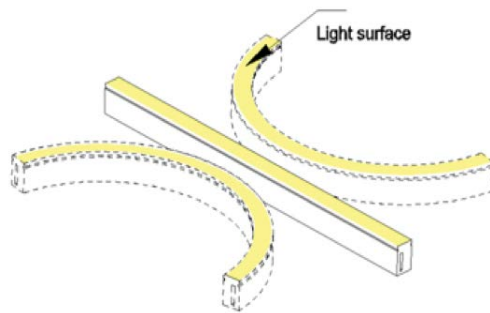

- Convenient for artistic design and decoration.

FOUR SIZES OPTIONAL

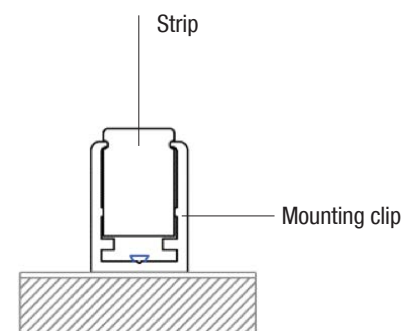
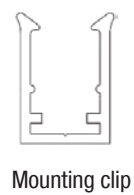
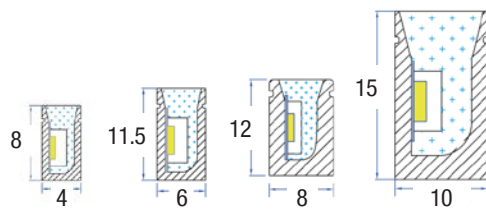

- Options for dealing with different installation circumstances.

CABLE FROM : END/SIDE/BOTTOM

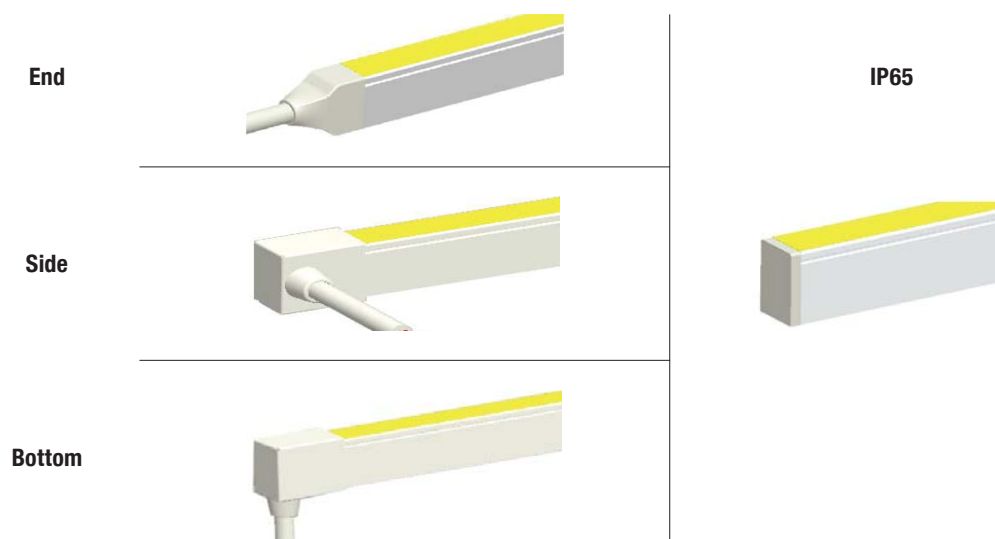

ACCESSORIES



Cable & Front Cap (IP67)



End Cap (IP67)



Mounting Clip

Full set of installation accessories. (front-end cap, mounting clip and cable) Easy cutting and connection.

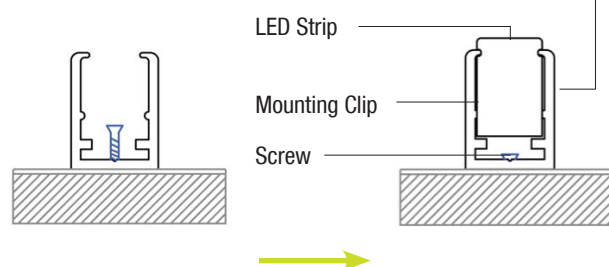

CUTTING UNIT

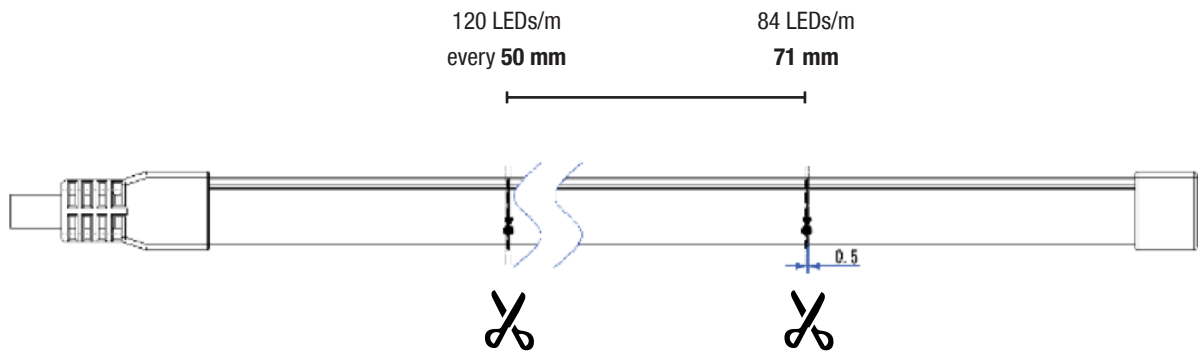

Can be cut along the cutting mark on the side of strip.

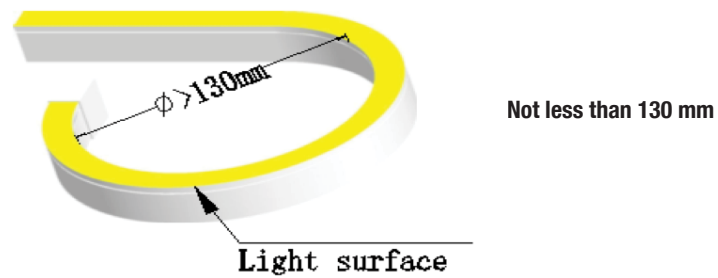

The strip can be bent along two lateral side but not less than 130mm of bending diameter.

ALUMINUM PROFILE

In addition to general installation accessories, there are four exclusively designed installation Aluminum profiles as optional accessories.

4 mm

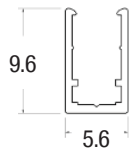

6 mm

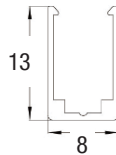

8 mm

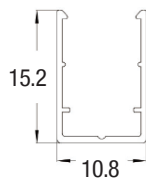

10 mm

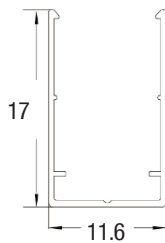

EASY SELF-CUTTING AND CONNECTION PROCESS



Step 1. Find the cutting line mark.



Step 2. Split the strip along the cutting mark by knife.

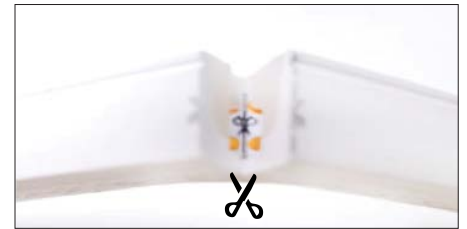

Step 3. Cut the PCB along the cutting mark inside the strip by scissors .

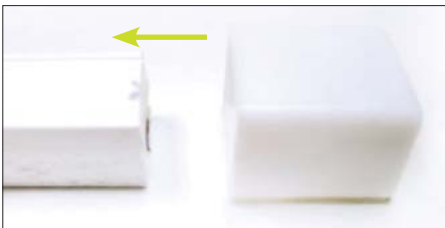

Step 4. Fix the strip end into end cap.

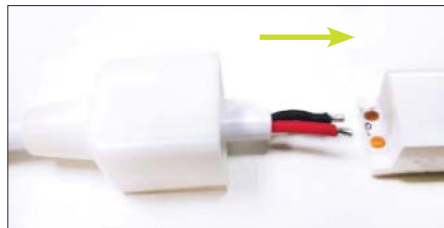

Step 5. Solder the cable onto PCB and connect the strip front and front cap.



Step 6. Use silicone glue to adhere end cap and front cap.

STRIP LED DOT FREE ACCESSORIES

“O” Type



Dot Free Type “O” 8mm Extension Connector
3ILDFOEXC8



Dot Free Type “O” 8mm Strip To Strip Connector
WW-3ILDFOSTSC8



Dot Free Type “O” 8mm Strip To Wire Connector
3ILDFOSTWC8



Dot Free Type “O” 8mm End Cap Connector
3ILDFOECC8

Profili - Profile



Moldable Profile

4mm “O” Type 3ILLG0510-500
6mm “O” Type 3ILLG0712-500
8mm “O” Type 3ILLG0911-500
Confezione 5m / pack 5m



Aluminum Profile

4mm “O” Type 3ILAP1006-100 _ 1000mm Lenght
6mm “O” Type 3ILAP0813N-100 _ 1000mm Lenght
8mm “O” Type 3ILAP1510-100 _ 1000mm Lenght
10mm “O” Type 3ILAP1712-100 _ 1000mm Lenght



PC Mounting Clip

4mm “O” Type 3ILPC1006-0025 _ 25mm Lenght
6mm “O” Type 3ILPC0813-0025 _ 25mm Lenght
8mm “O” Type 3ILPC1611-0025 _ 25mm Lenght
10mm “O” Type 3ILPC1713-0025 _ 25mm Lenght